



ETE LABORATORY

Daffodil International University



Department of Electronics and Telecommunication Engineering

Specialized Laboratory Equipment



Microwave Communication Trainer

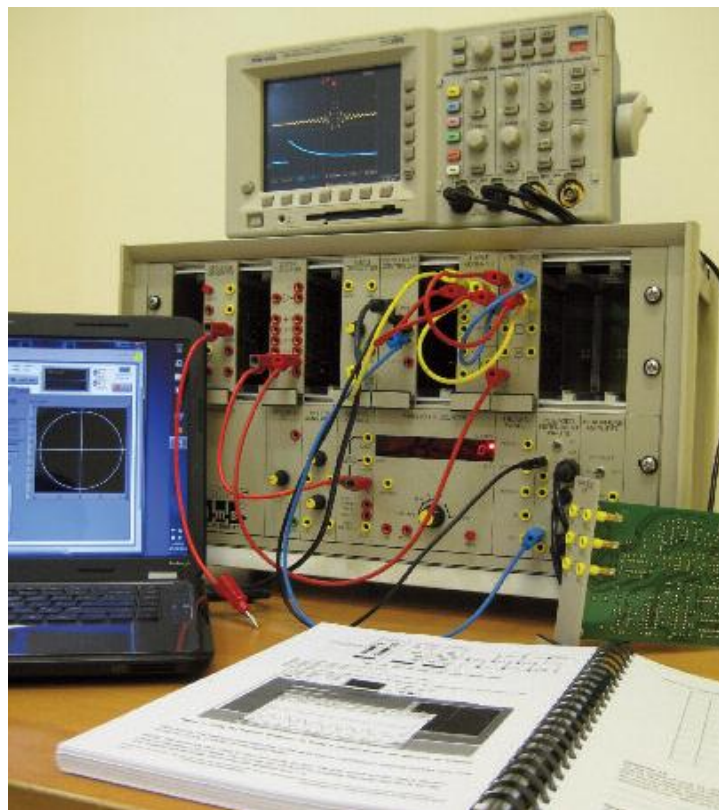

Wireless Communication and Signal Trainer



Digital Communication Trainer

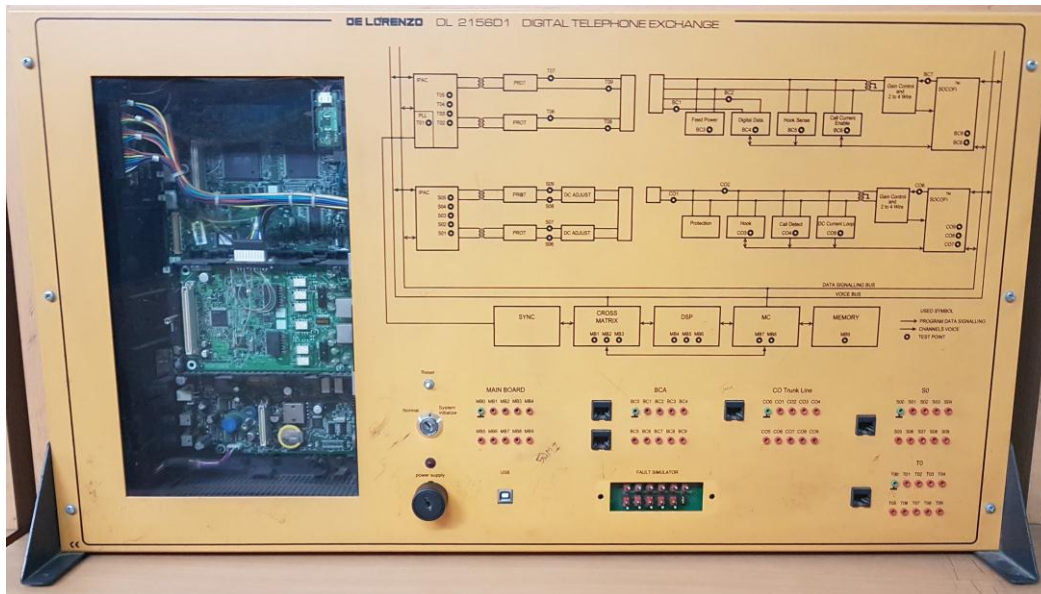

Digital Telephone Exchange



Digital Oscilloscope

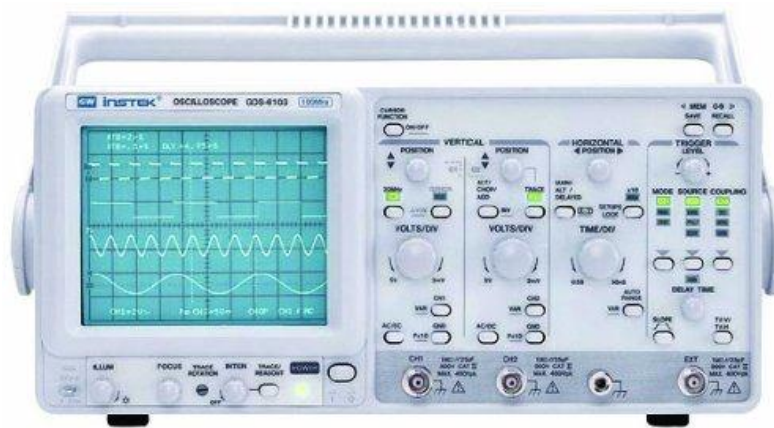

Analog Oscilloscope



Function Generator

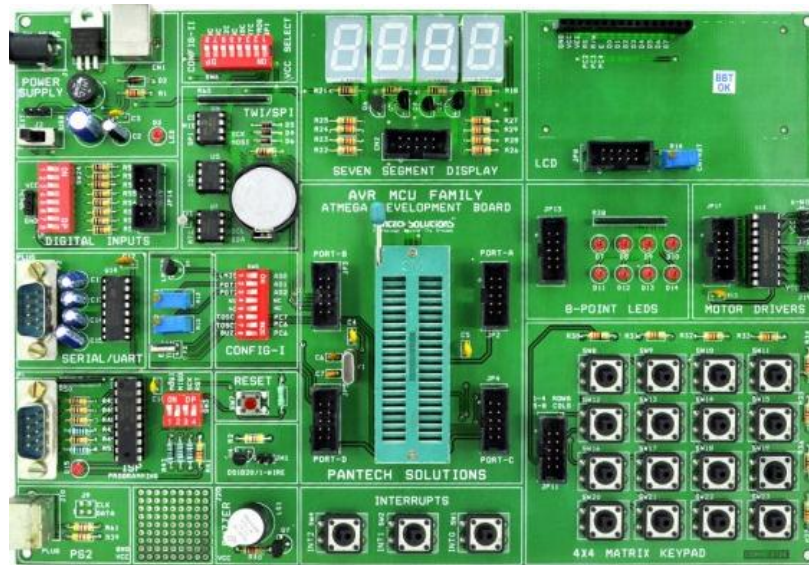

Micro controller Development Board



PC based Optical Fiber Trainer

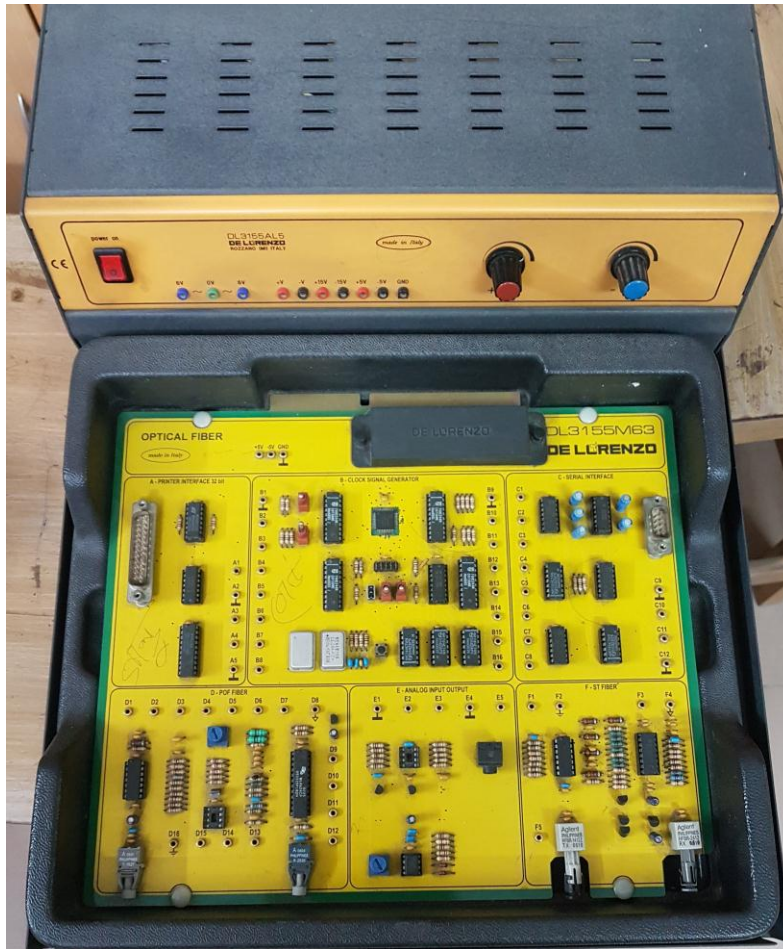

PC based Mobile Telephony Trainer



Mobile Communication Trainer

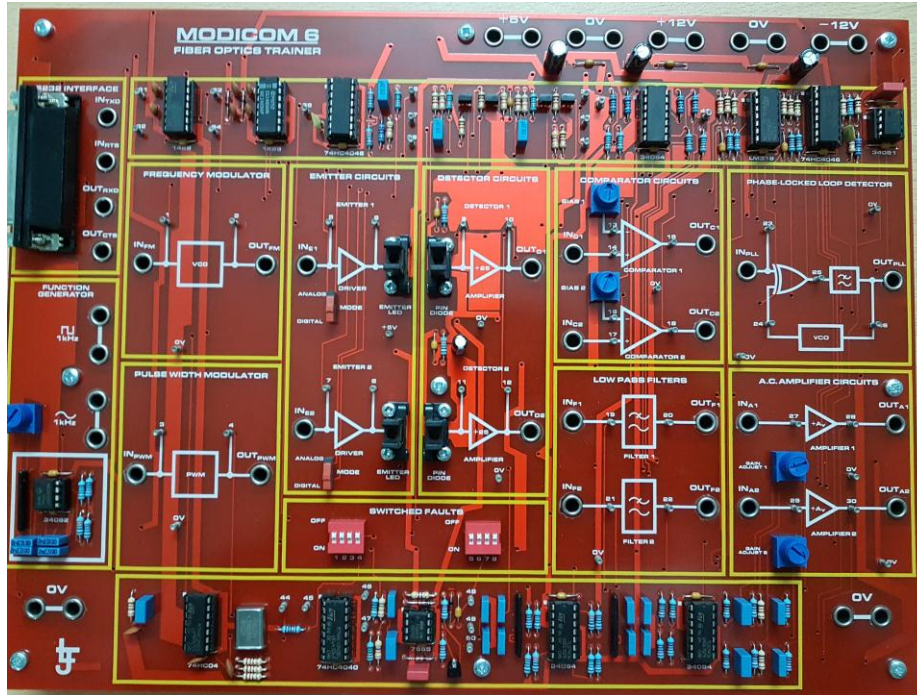

Optical Fiber Trainer Module

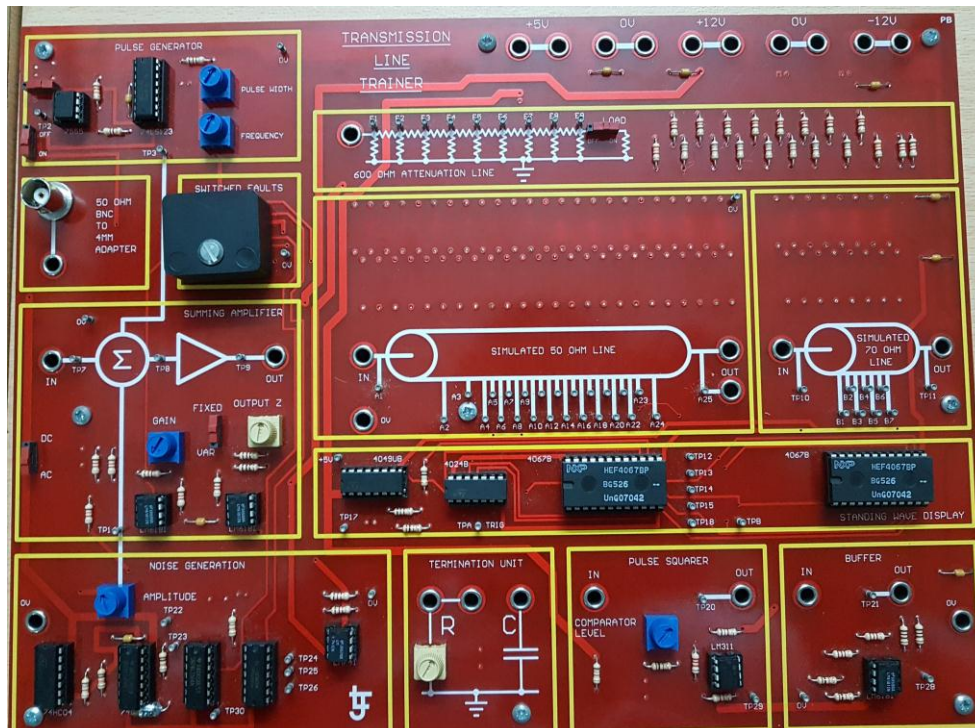

Transmission Line Trainer Module

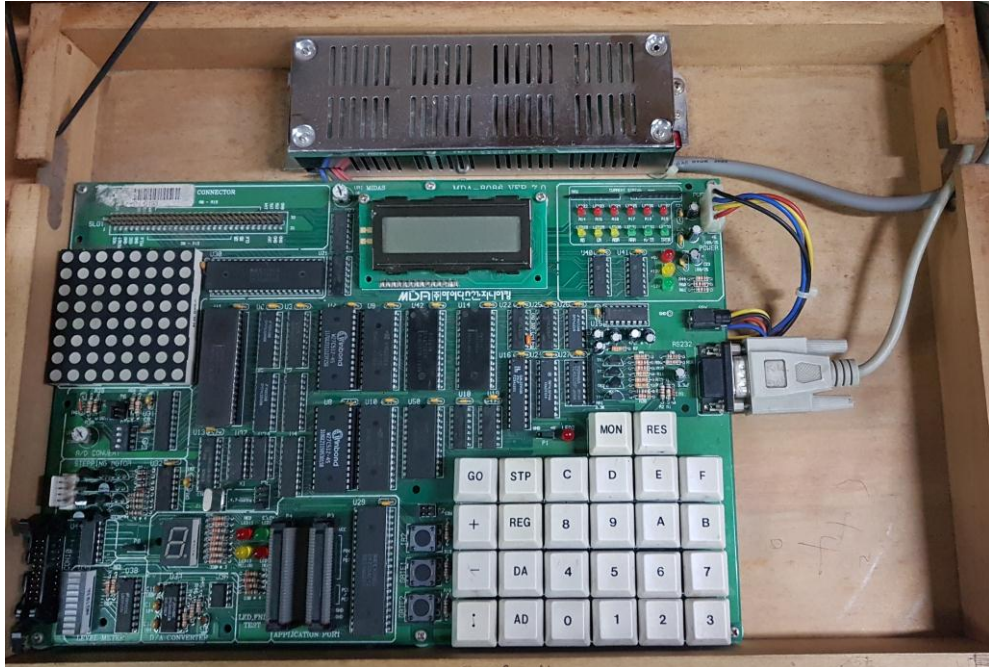

Microprocessor Trainer Kit

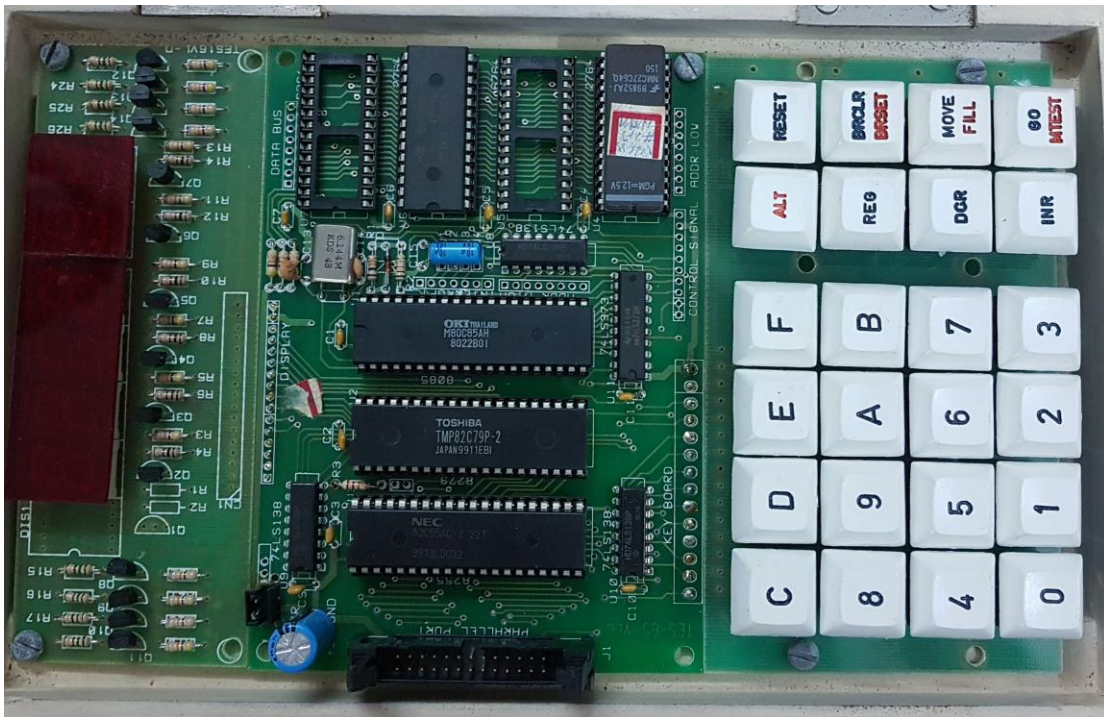

Digital Signal Processing Kit



FPGA Trainer Kit

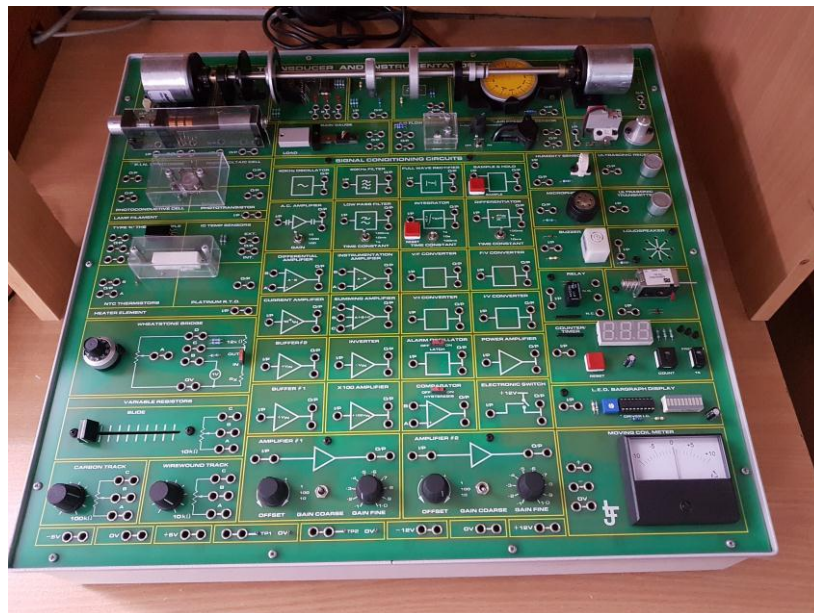

Transducer Module

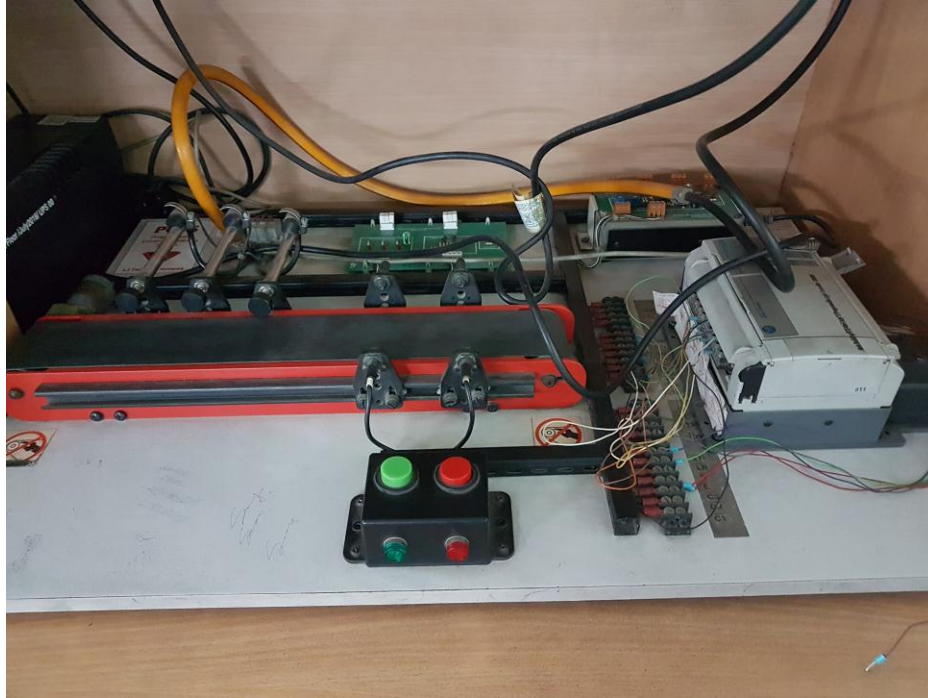

PLC Trainer Kit

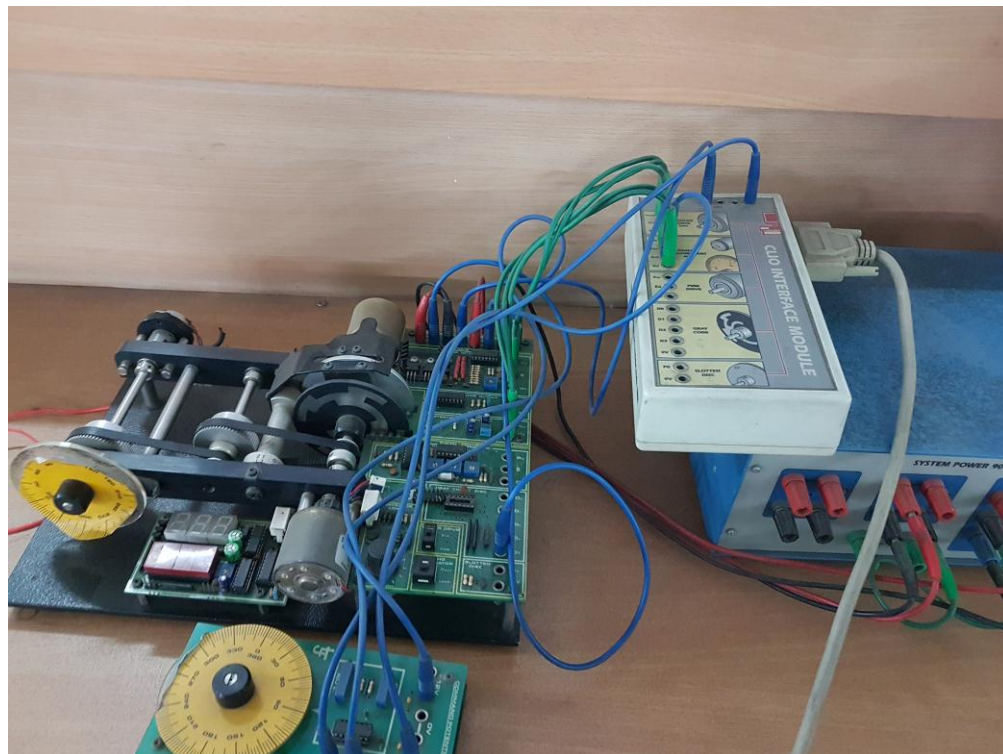

Motor Controller

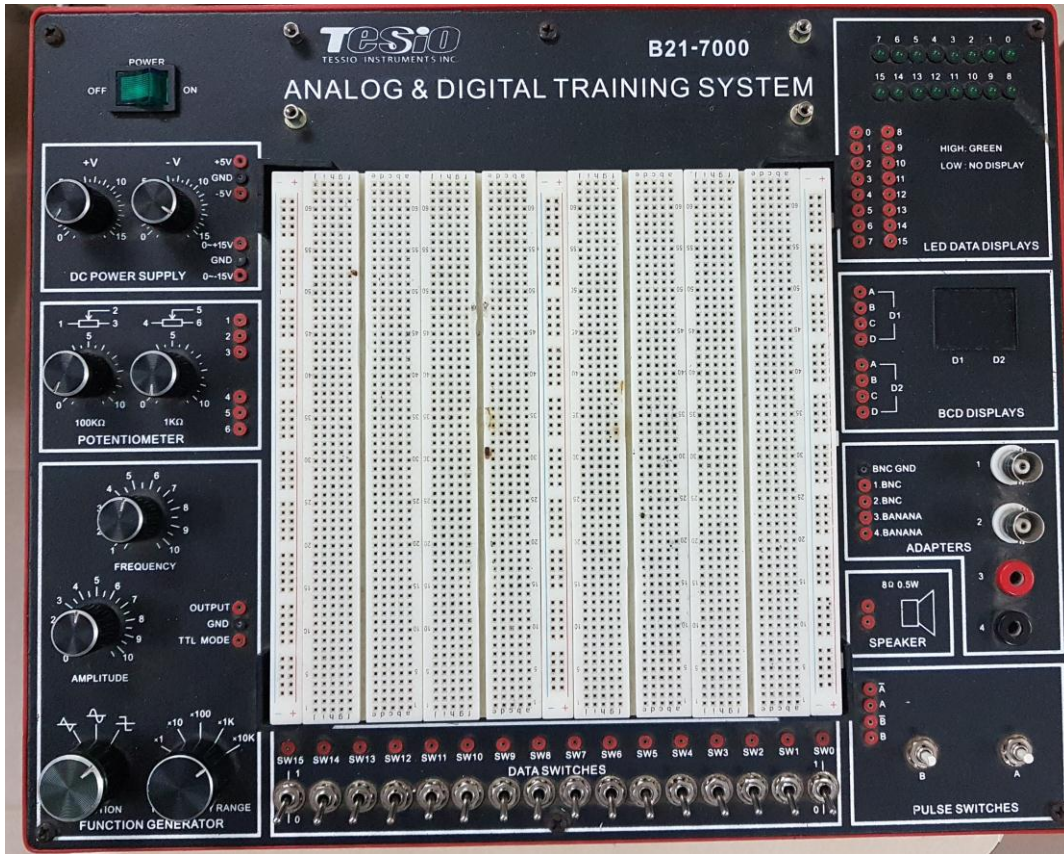

Trainer Board

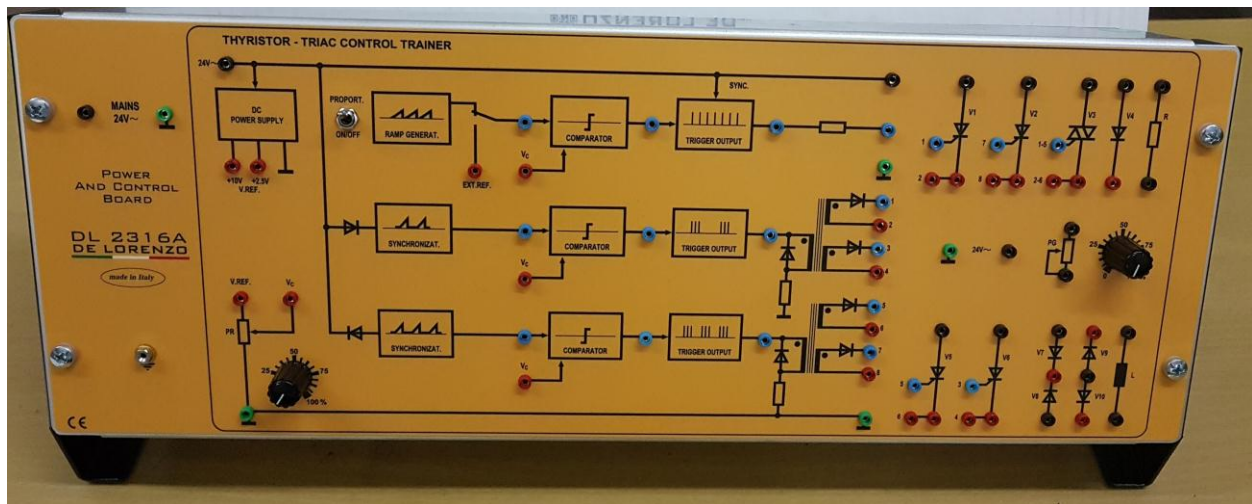

Power and Control Board Module

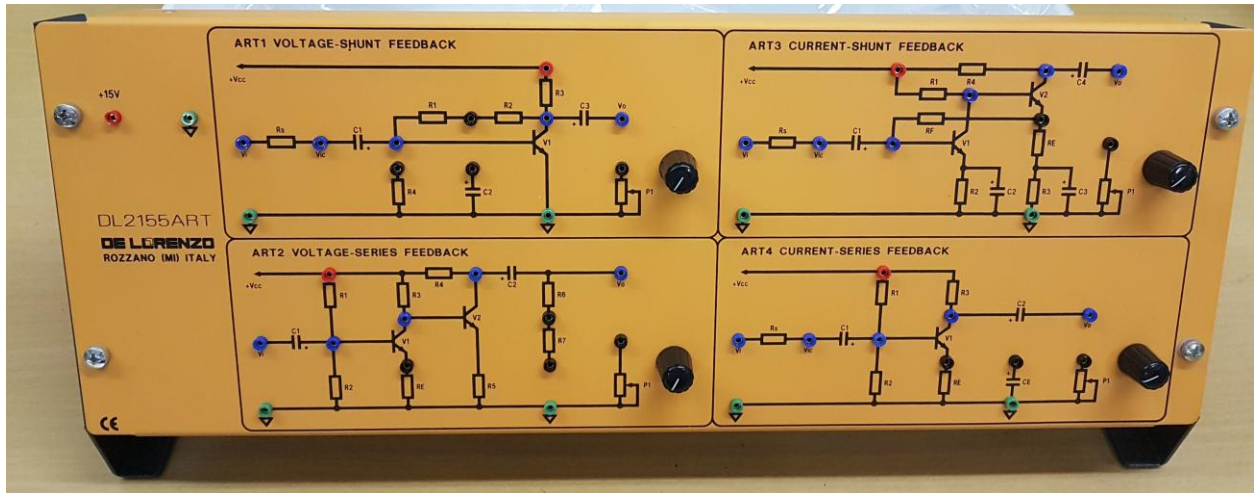

Feedback Amplifier Module

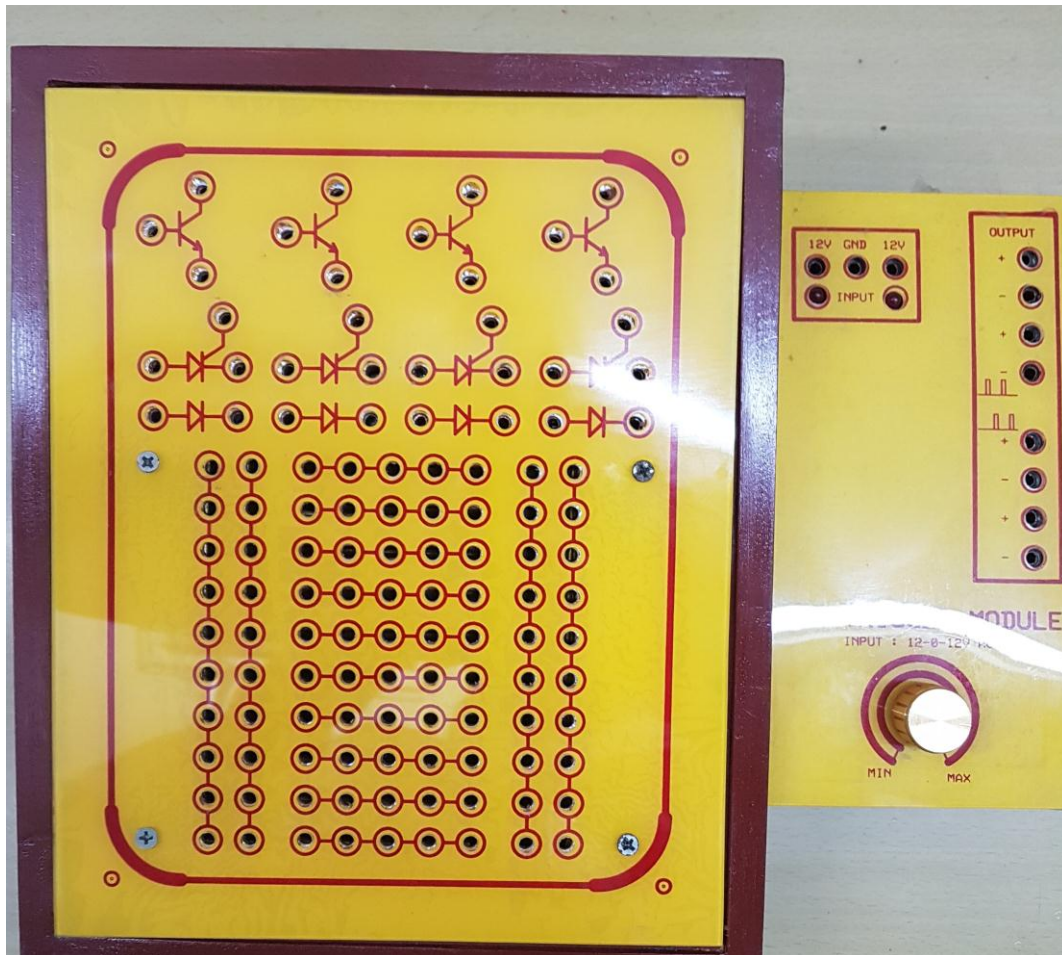

Industrial power Board

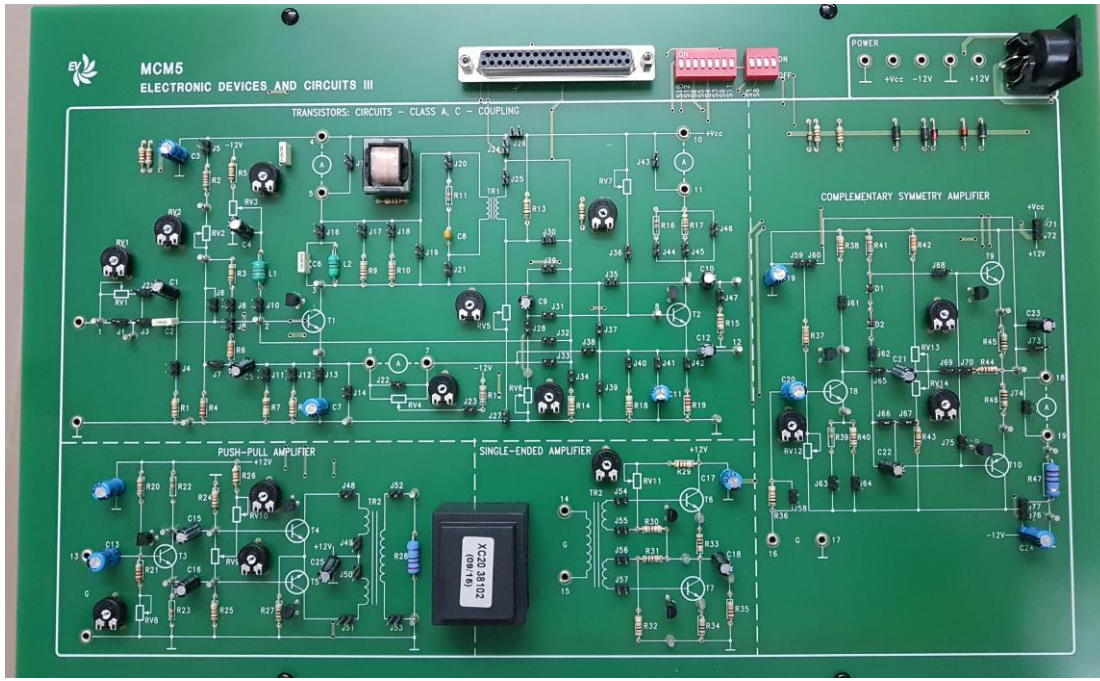

Power Amplifier Module

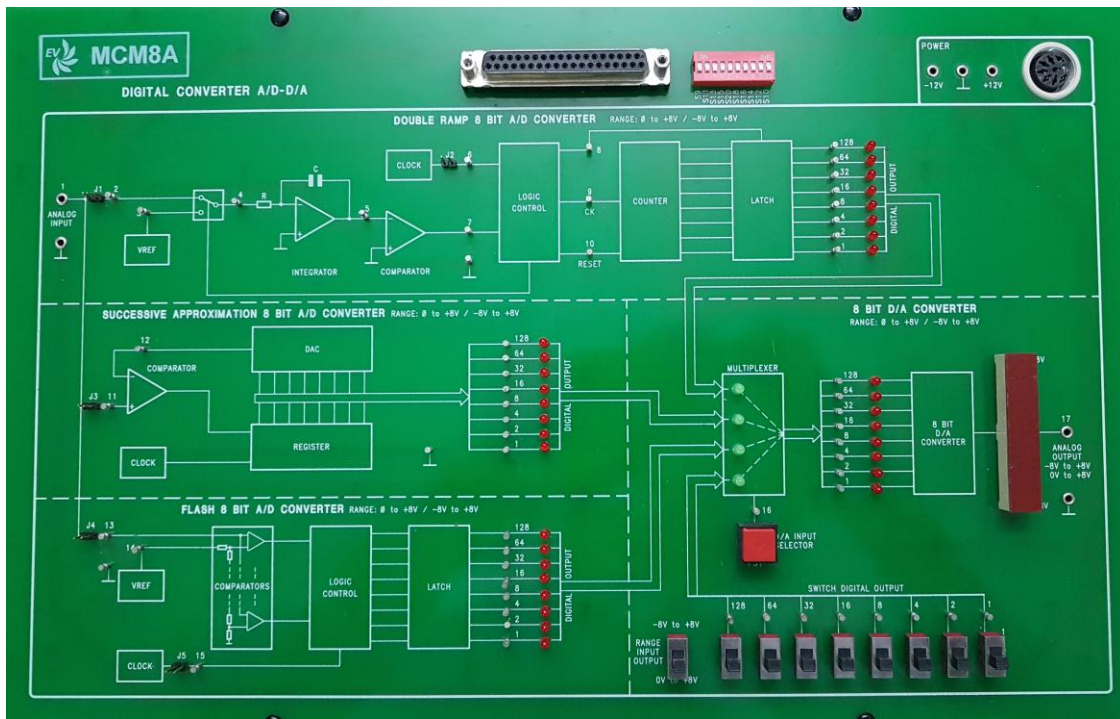

Digital to Analog and Analog to Digital Converter

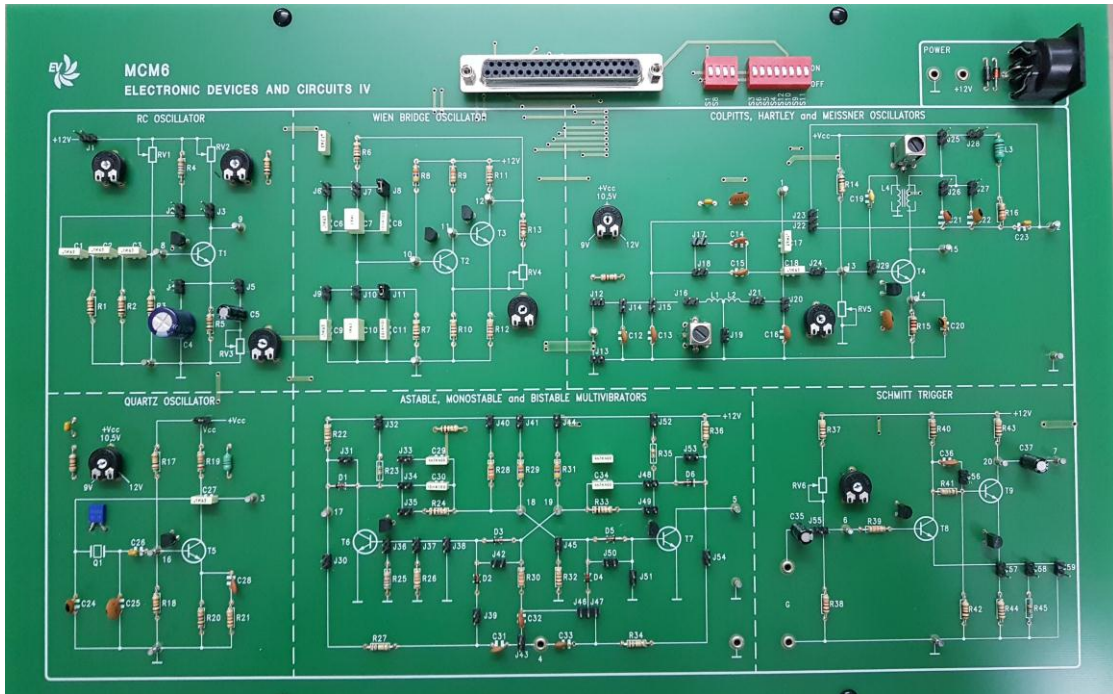

Oscillator Circuit Module



Trainer Board

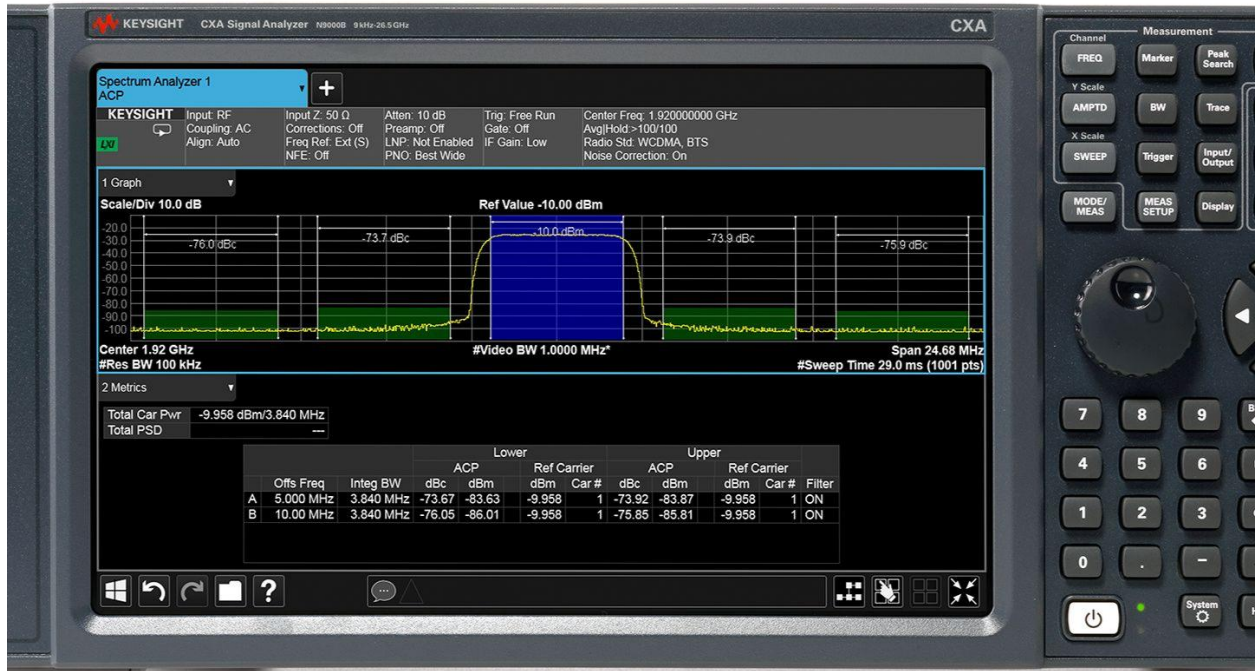

Spectrum Analyzer